

# User Manual

## RazerCam™ AHD 7" Monitor, NTSC Camera, and Cable



DM Part Number(s)	Description(s)
DMRZ-H7C1	This RazerCam™ kit includes one (1) AHD 7" monitor, one (1) AHD 170° NTSC camera, one (1) 15' shielded video flex cable, and accessories.

**Always read the manual prior to operating this equipment. Also, please follow all safety signs and precautions.**

**Table of Contents**

Included Components ..... 4

Standard Features..... 5

    RazerCam™ Camera ..... 5

    Monitor..... 5

    Cables ..... 5

RazerCam™ Wide-Angle Camera Detail ..... 5

RazerCam™ Installation ..... 6

    General skid-steer Camera Installation ..... 6

Monitor Installation & Mounting ..... 6

    Mounting Precautions..... 6

Power ..... 6

    Hardwire Power Adapter ..... 6

    Fuses..... 6

Monitor Operations ..... 7

    Monitor Operations ..... 7

    Remote Operations..... 7

Monitor Wire Harness Details ..... 7

    Harness Components..... 7

    Event Trigger Wire Color Guide..... 7

    Event Trigger Wires Explained..... 7

Cable Routing & Warnings ..... 8

Menu Settings..... 8

Specifications..... 9

Warnings..... 10











Product Warranty/Repair Process..... 10

Consumer Limited Warranty ..... 11

Disclaimer ..... 11

Intentionally  
Left Blank

**Included Components**

Description	Picture
<p>Dakota Micro® AHD 7" Monitor</p>	
<p>Dakota Micro® AHD 7" and 9" Monitor Wire Harness <b>PN: DM-MWH</b></p>	
<p>Dakota Micro® 7" Monitor U-Bracket and Hardware <b>PN: DM-H7BRKT</b></p>	
<p>Dakota Micro® 7" Monitor Sun Shade <b>PN: DM-7SHADE</b></p>	
<p>Dakota Micro® AHD 7" and 9" Monitor Remote <b>PN: DM-HRMT</b></p>	
<p>RazerCam™ AHD 170° NTSC Camera <b>PN: DMRZ-HC</b></p>	
<p>RazerCam™ Camera Universal Bracket <b>PN: DMRZ-CBKT</b></p>	
<p>Dakota Micro® Neodymium Magnet and Hardware <b>PN: DM-CM</b></p>	
<p>Dakota Micro® 2.1 Barrel Male to Auxiliary Power <b>PN: DM-12V</b></p>	
<p>Dakota Micro® 2.1 Barrel Male Hardwired Power <b>PN: DM-HDWRE</b></p>	
<p>AgCam®/EnduraCam®/RazerCam™ 15' Shielded Power Video Flex <b>PN: DMAC-EC15</b></p>	

## Standard Features

### RazerCam™ Camera

- True HD Resolution (720P)
- 1 Year Warranty
- 16:9 aspect ratio, so the image doesn't need to be "stretched" to match monitors
- Improved color and clarity over standard analog video cameras
- Increased ability to interpret shadowed areas, allowing for a larger viewing area
- Built-in, high-quality CCD camera with high-performance lighting
- Built-in IR lighting
- Waterproof
- Standard camera lens features a 170° Wide Angle horizontal field of view

### Monitor

- Features the latest in Analog HD technology
- LED backlit
- View both NTSC and PAL cameras
- Advanced LCD technology allows you to clearly see your image from any angle
- Mirror the view of any of your cameras for use as a backup camera
- 2-year warranty
- 16:9 aspect ratio
- 4 camera inputs
- Event triggers for each camera allow for triggered events to bring your camera to full view (I.E. putting the vehicle in reverse)
- Color, brightness, contrast, and volume controls that allow comprehension for use in different environments.

### Cables

- Made in the USA
- Silicone jacketing resists heat, cold, compression, & crimping
- Gold plated, corrosion resistant pins
- Watertight connections
- ¼ twist-lock keeps cables securely locked together
- Our durable power/video extension cables come in 10, 15, 20, 30, 40, 50, 60, 80 foot lengths
- 1 Year Warranty

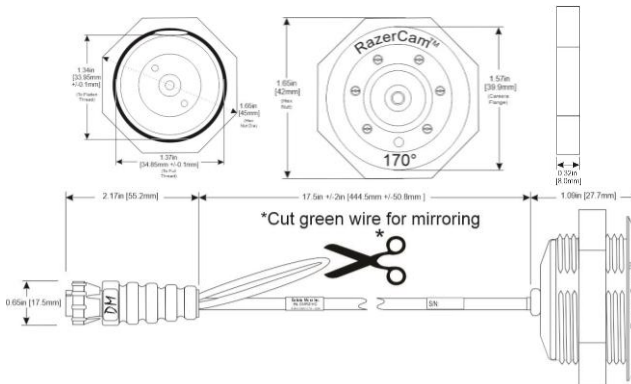

## RazerCam™ Wide-Angle Camera Detail



## RazerCam™ Installation

- Camera kit installation will vary based upon the model and brand of Skid-Steer you are utilizing
- The RazerCam™ camera system is an independent aftermarket system and installation of this camera may void manufacturer warranty. Check with your manufacturer for details.
- The primary reason for the varying installation is the location of the muffler in the rear compartment, requiring the use of a heat shield during the camera installation process.

### General skid-steer Camera Installation

<p>Locate Universal RazerCam™ camera bracket</p>	
<p>Remove the securing nut from the rear of the RazerCam™ Camera.</p> <p>Place the camera into the camera mounting bracket as shown (RazerCam™ to the top), and screw securing nut back onto the camera, sandwiching the camera bracket between the camera and securing nut.</p> <p>Mount RazerCam™ in its desired location. Image to right shows camera mounted using a Dakota Micro® magnet (DM-CM). There are also a variety of screw holes in the bracket to allow for multiple mounting options.</p>	

## Monitor Installation & Mounting

### Mounting Precautions

Remove your monitor carefully from packaging and inspect all mounting hardware. Mounting location is the most important part of the monitor installation as it ensures you the maximum visual benefit from your Dakota Micro system. With that said, when installing your monitor, ensure to follow these three (3) precautions:

1. The monitor is out of direct sunlight. This will prolong the life of the unit as well as ensure optimum visibility.
2. The monitor does not obstruct view.
3. The monitor does not interfere with the normal operation of equipment.

**Warning:** Dakota Micro, Inc. is not responsible for any damages caused to your monitor or yourself due to the improper installation or use of a suction cup monitor mount, whether it be product sold by Dakota Micro or product purchased from another source.

## Power

### Hardwire Power Adapter

1. Attach the flying leads to a key powered source. (red= power & black= ground)
2. Attach the power input connector on monitor to your included hardwire power adapter.
3. Dakota Micro hardwire power adapters have a maximum circuit capability of 5 amp.

### Fuses

1. There is a small in-line glass fuse located on the red power wire. When replacing this fuse, use a MAX 3 AMP glass fuse.
2. There is a small glass fuse located on the inside tip of the 12v portion of the power adapter (PN: DM-12v). When replacing this fuse, use a MAX 4amp glass fuse.

**Monitor Operations**  
Monitor Operations

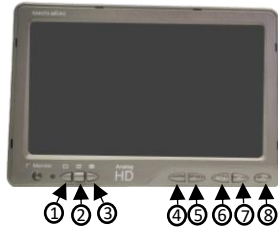

1		Non-Functional
2		Non-Functional
3		Non-Functional
4	- Key	To Decrease parameter
5	+ Key	To Increase parameter
6	MENU	Allows users to access the menu. Once in the menu, toggles through menu options
7	AV	Each button press switches between AV1, AV2, AV3, & AV4. Also, selects menu options within sub menus.
8	Power	Powers Monitor ON and OFF (2 Second delay)

**Remote Operations**

	POWER ON/OFF
	Decrease parameter or toggle menu settings ON/OFF
	Increase Parameter or toggle menu settings ON/OFF
	VIDEO SELECT- Manually toggles between cameras, AV1, AV2, AV3, AV4, and then back to AV1. Also, moves up within sub menus.
	Changes the view of the screen 16:9 and 4:3 or moves down through the sub menu options.
	MENU- Allows users to access menu. Once in menu, toggles through menu options.



**Monitor Wire Harness Details**

**Harness Components**

1. Input to Monitor
2. AV 1-4 Event Trigger Wires
3. Fuse
4. Power Input
5. RCA- Video Output
6. AV1- Audio/Video Input
7. AV2- Video Input
8. AV3- Video Input
9. AV4- Video Input



**Event Trigger Wire Color Guide**

1. Camera 1- Green
2. Camera 2- Purple
3. Camera 3- Gray
4. Camera 4- White

**Event Trigger Wires Explained**

Event trigger wires can be attached to any 12v or 24v positive output event switch or supply. The event circuit should be neutral in its normal state and change to HIGH (12v or 24v) when the event is active. This will cause the monitor to automatically switch to that camera, regardless of the state of the monitor (i.e. ON/OFF or different channel selection). Up to 3 cameras can be triggered on and simultaneously displayed at the same time. For example, if you have trigger wires 2 and 4 hooked up to a positive event, a split screen of cameras 2 and 4 will be displayed. You can also set a camera to be a priority so when it is triggered it will override any other image to full screen. See Menu Setting for more details.



## Cable Routing & Warnings

Your skid steer kit includes one (1) 15' power video extension cable. If you would like to purchase different or additional cable lengths, please contact your local Dakota Micro, Inc. dealer. There are any number of ways you can route your power/video extension cable from your monitor back to your camera; we will leave that up to the individual users. Cable routing is important; where you choose to run the cables should not interfere with the normal operation of the machine or safety equipment.

- ALWAYS be aware of any “pinch points” or other potential hazards to the cable(s)
- Secure all cables to vehicle/equipment using cable clips, zip ties, or other style fastener.

## Menu Settings

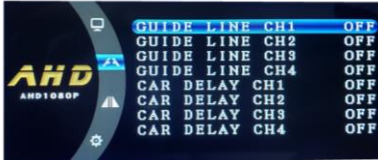
1. Press the MENU key on the monitor or remote to bring up the menu.
2. Press the MENU key again to toggle through the menu options.
3. Use the – and + keys on the monitor or the Left and Right arrow keys on the remote to change the value of the highlighted item.
4. Use the AV on the monitor or Video/Mode Select on remote to move up and down through the individual menu selections.
5. To exit, allow monitor to time out (approx. 15 seconds) or exit the menu faster by pressing the menu button to go through all the menu options.

	<p><b>Brightness:</b> Adjusts the brightness of the image.</p> <p><b>Contrast:</b> Adjusts the contrast of the image.</p> <p><b>Saturation:</b> Adjusts the saturation of the image.</p> <p><b>Tint:</b> Adjusts the tint of the image.</p> <p><b>Volume:</b> Adjusts the volume level.</p>
	<p><b>Guideline CH1-4:</b> Allows user to turn ON/OFF guides. Guidelines appear only during triggered events.</p> <p><b>Car Delay CH1-4:</b> Allows user to set duration of triggered camera on individual camera.</p>
	<p><b>Rotate:</b> Allows user to rotate the whole image for all channels.</p> <p><b>Mirror CH1-4:</b> Allows user to choose specific channels they may want to mirror.</p>
	<p><b>Language:</b> Allows user to change the language.</p> <p><b>AV1-4 Loop 3s:</b> Allows user to have images automatically change on a 3 second loop.</p> <p><b>No Signal:</b> Allows user to change the color of the screen when there is no camera signal.</p> <p><b>Zoom:</b> Changes the screen between 16:9 and 4:3</p> <p><b>Auto Dim:</b> Turns auto dim on/off</p> <p><b>Reset:</b> Factory Reset</p> <p><b>VER:</b> Latest version of the monitor</p>



**Specifications**

<b>LCD Monitor</b>	
Screen Size	16:9 Digital Panel
Overall Size	4.84in(123mm) (H) x 7.04in(179mm) (W) x 1.14in(29mm) (D)
Weight	396g
Power Input	DC 12-24v
Color System	NTSC/PAL auto switch
Operating Temp.	-30°F(-20°C) ~158°F(70°C)
Brightness	800cd/m <sup>2</sup>
Resolution (HxV)	1024(H)x600(V)
Contrast	500:1
Viewing Angle	L/R: 85° Up: 85° Down: 85°
Operating Voltage	Min. 12v (Check monitor label for specific voltage range)
Lighting Source	LED Backlight
Video Output Port	1 RCA Video Out- Analog (CVBS) ONLY
Video Input Port	4 AHD video input channels
<b>Camera</b>	
Video System	NTSC
Video Type	Analog High Definition
Image Pickup Device	CMOS
Horizontal Resolution	720P
Minimum Illumination	0.01 LUX@F1.2
Image Ratio	16:9
Auto Gain Control	Automatic based on lighting
Scanning System	Progressive
Camera Board Lens	170° Field of View
Operating Temp	-40°F (-40°C) – 185°F (85°C)
Construction	Aluminum Case
Waterproofing Criteria	IP69K
Dimensions	1.76in (W) x 1.09in (D)
Camera Connector	5 pin Conxall/ Switchcraft
LED Lighting	Visible White Light
<b>Extension Cable</b>	
Connector Type	5 pin Conxall/ Switchcraft
Cable Type	Dual Core 26 AWG, Silicone Jacketed
RoHS Compliant	Yes
Shielded	Yes
Strain Relief	Over molded
Watertight Connections	Yes
Operating Temp.	-45°F (-42°C) ~ 150°F (66°C)
Max Recommended Pulling Tension	10 lbs

## Warnings

1. When selecting a camera system from Dakota Micro, Inc., be sure to utilize the appropriate system for your use. AgCam®, EnduraCam® and InnoPro® cameras are designed for high impact, moisture, vibration, and a variety of other rough conditions. OverView® and RazerCam™ cameras and kit components are designed for light use, low vibration, and low moisture. OverView® and RazerCam™ equipment is not warranted when used in situations outside of the above-mentioned parameters. We always request that customers keep in mind that our less expensive OverView® and RazerCam™ product line is cheaper because it does not feature the reliability and durability of our AgCam® and EnduraCam® lines. The warranty available on these products reflects that durability.
2. To avoid electrical shock and maintain optimal functionality, do not open the enclosures. High voltage may be present and there are no user serviceable parts inside. All warranties will be void should any enclosures be tampered with in any way.
3. Do not use any harsh chemical solvents, cleaning agents or corrosive detergent to clean away dirt on the surface of the screen or lens.
4. On AgCam® and EnduraCam® products, the photo-chromic camera lenses have been made impact-resistant and have been drop-ball tested according to Sec. 3.84,21 CRF BUT ARE NOT UNBREAKABLE. Because they have been hardened chemically, they show no stress pattern. Inspect your lenses frequently. Chipped or scratched surfaces will reduce protection. Such lenses should be replaced only by the manufacturer.
5. Power to cameras is not interrupted by turning off monitor; 12v power source must be terminated when not in use to avoid battery drain. To avoid this problem be sure when hard wiring a unit, use a fused circuit.
6. Do not use your Dakota Micro, Inc. camera system for anything other than legal surveillance and observation uses. Dakota Micro, Inc. is not liable for any illegal or nefarious usage.

## Product Warranty/Repair Process

1. For Technical Support call 1 701-538-4403 OR email techsupport@dakotamicro.com
2. Technician will assist in troubleshooting product malfunction.
3. If product malfunction cannot be remedied and a repair is deemed necessary, Technician will issue a case number.

**IMPORTANT NOTE:** *The Technician will note if the repair APPEARS to be a warranty or non-warranty issue based on customer description of the issues at hand. No final determination can be made until inspection and testing of the equipment is completed at the factory.*

4. To ensure fast and effective repairs, customer is required to send:
  - Dakota Micro, Inc. product that technician has requested/deemed necessary in the proper diagnosis and repair of malfunction. This may include some or all components of the kit.
  - Original/Copy of purchase receipt.
  - For serialized items ONLY, if a copy of the original purchase receipt cannot be provided, then Dakota Micro, Inc. will use the product manufacture date.
  - Customer information, including return address, phone number & email address.
  - Case Number provided by Dakota Micro, Inc. technical support
  - Shipping and associated costs to ship product to Dakota Micro, Inc. factory to be borne by the customer unless otherwise specified.
5. Customer should mail product to:
 

Dakota Micro, Inc.  
Case # XXXX  
8659 148 ½ Ave. SE  
Cayuga, ND 58013
6. Upon receipt and evaluation of product at Dakota Micro, Inc. factory, it will be established if the repair is warranty or non-warranty. Customer will be notified of any applicable charges.
7. If the repairs are deemed non-warranty and require a service/repair fee of any kind, a credit card number will be required.
8. If customer is unable to be contacted over the course of 3 weeks regarding required non-warranty repairs, product will be held for 30 days and, if no response from customer, product will be discarded.
9. Any product returned without proper documentation may be returned at customer's expense.
10. Product returned with unconfirmed problems may be assessed an evaluation fee of up to \$60 per unit.
11. Return shipping costs will be borne by the party at fault; in other words, if Dakota Micro, Inc. determines that the defective product was covered under warranty, Dakota Micro, Inc. pays the shipping charges. If Dakota Micro, Inc. determines that it was the customers fault, the customer will pay shipping charges. If a particular circumstance cannot be determined then the cost of shipping charges will be decided on a discretionary basis depending on the situation at hand.

## Consumer Limited Warranty

Subject to the disclaimer, limitations and other directions stated hereafter, Dakota Micro, Inc. warrants that the Product will be free from defects in material and workmanship for periods as stated hereafter from the date of original purchase. **THIS WARRANTY IS EXPRESSLY MADE IN LIEU OF ANY AND ALL OTHER WARRANTIES, EXPRESS OR IMPLIED, INCLUDING THE IMPLIED WARRANTIES OF MERCHANTABILITY OR FITNESS. THE EXCLUSIVE REMEDY OF THE BUYER IS LIMITED TO REPAIR OR REPLACEMENT OF THE PRODUCT. EXCEPT AS STATED IN THIS WARRANTY, DAKOTA MICRO, INC. SHALL NOT BE LIABLE FOR ANY LOSS, INCONVENIENCE, OR DAMAGE, INCLUDING DIRECT, SPECIAL, INCIDENTAL, OR CONSEQUENTIAL DAMAGES, RESULTING FROM THE USE OR INABILITY TO USE THE PRODUCT, WHETHER RESULTING FROM BREACH OF WARRANTY, NEGLIGENCE, STRICT LIABILITY OF ANY OTHER LEGAL THEORY.** Any oral statements or representations made by anyone which are contrary to or at variance with the terms stated in this **LIMITED WARRANTY** are void.

Dakota Micro, Inc. will, at its option, either repair the defect or replace the defective Product or part thereof with a new or remanufactured equivalent at no charge to the purchaser for parts or labor for the period of five (5) years for AgCam® /EnduraCam® cameras; three (3) years for InnoPro® cameras; two (2) years for AgCam®/ EnduraCam® monitors, and Wireless components; Twelve (12) Months for all Overview® and RazerCam™ Cameras & Monitors, cables and all other accessories.

In addition to the five (5) years for AgCam® /EnduraCam® cameras Dakota Micro will warranty for the life of the camera against any variety of ingress within the camera housing. This includes moisture and dust particles that are found inside the camera resulting from a manufacturing defect and does not include ingress because of damage caused by no fault of Dakota Micro, Inc.

The Dakota Micro, Inc. limited warranty periods outlined above apply throughout the United States and Canada only. A one (1) year maximum limited warranty for all Products applies to all other geographic locations unless otherwise stated in writing by Dakota Micro, Inc.

This limited warranty does not apply to any issues connected with appearance that have no relation to the performance of the Product nor to any Product the exterior of which has been damaged or defaced, which has been subjected to improper voltage or other misuse, abnormal service or handling, or which has been altered or modified in design or construction.

In order to enforce the rights under this limited warranty, the purchaser should follow the process set forth in the Product Warranty/Repair Process, and provide proof of purchase to Dakota Micro, Inc.

Neither the sales personnel of Dakota Micro, Inc. nor any dealer or any other person is authorized to make any warranties other than those described herein, or to extend the duration of any warranties beyond the time periods described herein.

The warranties described herein shall be the sole and exclusive warranties and remedies provided by Dakota Micro, Inc. Correction of defects, in the manner and for the period of time described herein, shall constitute complete fulfillment of all liabilities and responsibilities of Dakota Micro, Inc. to the purchaser with respect to the Product, and shall constitute full satisfaction of all claims. In no event shall Dakota Micro, Inc. be liable or in any way responsible for any damages or defects in the Product which were caused by repairs or attempted repairs performed by anyone other than Dakota Micro, Inc.

Some states do not allow the limitation or exclusion of incidental or consequential damages, so said limitation may not apply to you.

Any action at law, suit in equity, or other judicial proceeding for the enforcement of any right provided for herein or otherwise, or with respect to any claim that a purchaser may have against Dakota Micro, Inc. shall be instituted only in the Courts of the State of North Dakota, either in the state district court located in Wahpeton, North Dakota or in Federal District Court located in Fargo, North Dakota. Without regard to conflicts of law principles, the laws of the state of North Dakota shall govern the interpretation and enforcement of the terms of this Limited Warranty and all aspects of the relationship between Dakota Micro, Inc., and the purchaser.

*This warranty gives you specific legal rights and you may also have other rights, which may vary from state to state.*

## Disclaimer

Dakota Micro Inc. products, specifications, pricing, and programs are subject to change without prior notice. Dakota Micro Inc. reserves the right to make design changes at any time without obligation to retroactively install them on previously sold units.



8659 148½ Ave. SE.  
Cayuga, ND 58013

[www.dakotamicro.com](http://www.dakotamicro.com)

*Management System Registered to ISO 9001*